

harper deep.

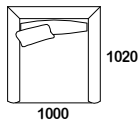

ARMCHAIR

HA100D



SOFA

HA186D
2.5 Seater

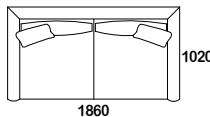

HA212D
3.0 Seater

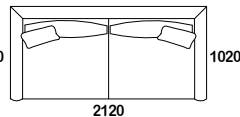

HA251D
3.5 Seater

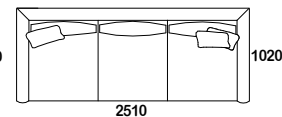

HA266D
3.5 Seater

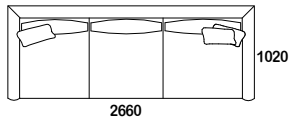

HA305D
4.0 Seater

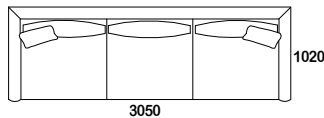

OTTOMAN

HA750

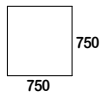

HA800

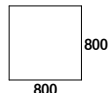

HA930

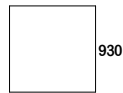

suitable for models: HA100/251D

HA186/266D

HA212/305D

SPECIFICATION

Structure// Solid plywood & timber w/ sprung base
 Seat cushions// High density foam w/ Feather Fibre wrap
 Back Cushions// Feather & Down
 Scatter Cushions// Feather
 Legs// Solid Oak

STAIN/UPHOLSTERY/FINISH

Upholstered in fabric or leather// Selection of timber stains// Optional contrast cushion(s)// Available in 880Dmm model

Australian Designed & Made.

Studio Pip

harper shallow.

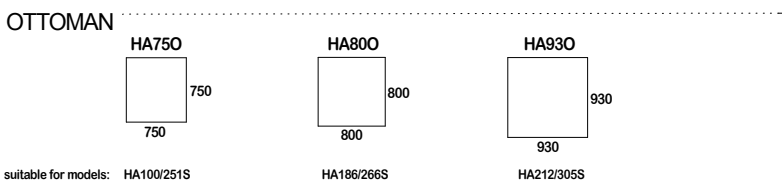
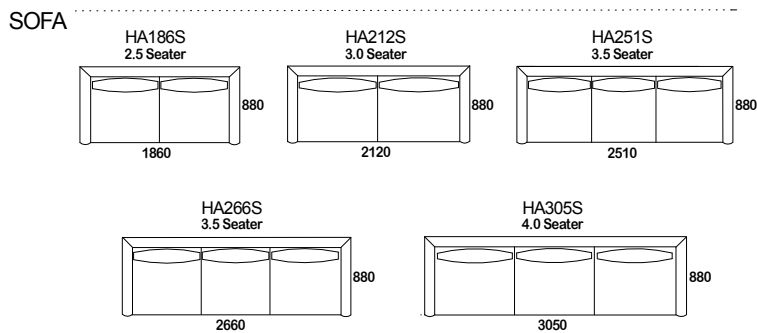
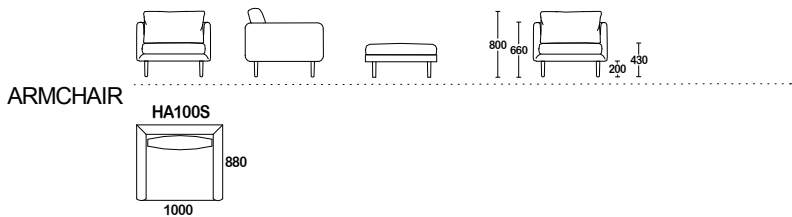

SPECIFICATION

- Structure// Solid plywood & timber w/ sprung base
- Seat cushions// High density foam w/ Feather Fibre wrap
- Back Cushions// Feather & Down
- Scatter Cushions// Feather
- Legs// Solid Oak

STAIN/UPHOLSTERY/FINISH

- Upholstered in fabric or leather// Selection of timber stains// Optional contrast cushion(s)// Available in 1040Dmm model

Australian Designed & Made.